

# Trappeskål / TAG-N 200-10-80

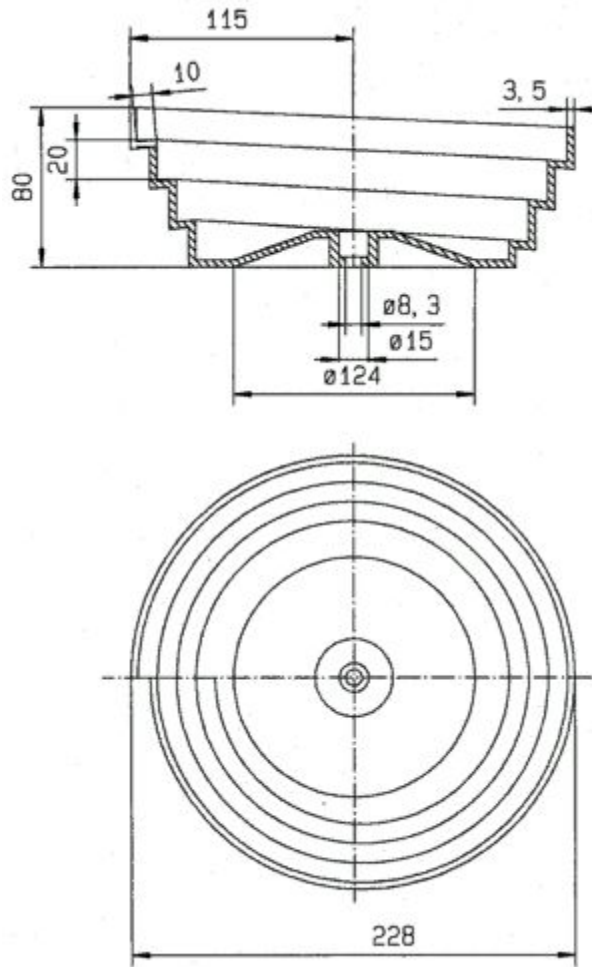

Vægt (kg)	Passer til	Matriale
0,8	SRC-N 200-2	Aluminium